

SULZER

Flow Equipment

HST™ turbocompressors for efficiency and reliability



An unbeatable combination of efficiency and reliability

With several thousands of units installed all over the world, the HST™ turbocompressor has become synonymous with high efficiency and excellent reliability. The energy savings, reduced CO₂ emissions and low maintenance cost it provides have all been well proven, securing market-leading life cycle costs and fast investment pay-back. It is noteworthy that the first machines, installed more than 20 years ago, are still running on the first set of bearings.

Today, we deliver multiple HST turbocompressors every single day of the year. Each one of them represents state-of-the-art technology. Using a purpose-built high-speed motor and digitally controlled magnetic bearings, it gives you the best total output for your energy input.

Discover why the HST turbocompressor has become the number one choice within its size range.



The HST turbocompressor in real life

Saving power at a wastewater treatment plant in New Jersey, USA

The township of Neptune Sewerage Authority (TNSA) in New Jersey, USA, owns and operates a wastewater treatment plant that serves Neptune and its surrounding neighborhoods. The plant is rated at an annual average flow of 8.5 million gallons per day (MGD) with an associated peak flow of 21.25 MGD.

By replacing their malfunctioning multi-stage centrifugal blowers with HST turbocompressors, the plant has been able to reduce power draw by 58%.



Boosting efficiency in a paper mill

When a paper mill equipped with two paper machines producing more than 500'000 tons of high-quality printing papers annually decided to upgrade their complete blower station, they opted for the HST turbocompressors.

The change resulted in significant energy savings of up to 10% and a dramatic noise reduction to less than 85 dBA. Also, the regular maintenance has been reduced to changing the air filters only.

Optimizing energy use in an energy-neutral sewage plant in Germany

The sewage treatment plant in Kaiserslautern, Germany, has a design capacity of 210'000 PE (population equivalents) and a daily inflow volume of around 60'000 m³. By replacing an older aeration system with a new one including three Sulzer turbocompressors the plant has reduced the energy demand of the biological stage by 50% at the same time increasing treatment performance.

Due to their magnetic bearings, the turbocompressors run quiet, provide fully flexible and almost maintenance-free operation and allow arbitrary on/off cycles without stressing other equipment.



HSTs in municipal wastewater treatment

Aeration of wastewater

The energy-efficient HST turbocompressor is the best choice for aeration in wastewater treatment. Its unique technology minimizes energy consumption, letting you dramatically cut your treatment plant energy bill. The simple-to-operate, wear-free design provides reliable assurance against breakdowns. With greater efficiency and greater reliability, you can expect total peace of mind – and big savings.

Continuous aeration with fine bubble membranes

Aeration with rubber membranes is standard today. The fine slits in the membrane produce millimeter-size bubbles that are suitable for aerating most wastewater compositions. The low temperature of the compressed air and the exact control of the pressure make the HST turbocompressor very suitable for use with fine bubble diffusers.

Disc diffusers
Plate diffusers
Tube diffusers

Mechanical and jet aeration

In cases where the wastewater composition or the chosen process require good resistance to chemicals and solid particles, or if the aeration need is intermittent, mechanical aerators or jet aeration are often applied. In such applications, it is common with frequent starts and stops. This is no problem for the HST turbocompressor. The low temperature of the compressed air from the HST turbocompressor will prolong the life of aeration components such as hoses and composite distribution pipes.

Jet aeration systems
Mechanical bottom aerators



Membrane bioreactors (MBR)

MBR represents an emerging technology where membranes are used to separate the clean water in conjunction with or after the activated sludge process. A common method of keeping the membranes clean is called air scouring. This means compressed air is released close to the membrane and the resulting pressure waves clean the membrane surface. Highly suitable for the varying flow demand in many MBRs, the HST turbocompressor can also handle the pressure variations induced by nozzle fouling and cleaning cycles without loss of efficiency.

Ultra-filtration membranes

Aeration of sand trap

Usually part of the pretreatment of municipal wastewater, the air injected into the sand trap helps separate sand and gravel and minimizes the risk of unwanted odors.

Coarse bubble diffusers

Aeration of equalization tanks

Equalization is performed by buffering the wastewater to make it more homogenous if the amount of flow or wastewater from difference sources induces variation. Here aeration will minimize odor and facilitate the biological processes that follow.

Mechanical aerators
Coarse bubble diffusers

Aerobic digesters

Most biological treatment processes will produce excess sludge. One step in stabilizing the sludge for further use or disposal is aerobic digestion. The varying need of air makes the HST turbocompressor a good choice for supplying air to larger size aerobic digestion tanks.

Mechanical aerators



HSTs in industrial applications

Pulp and paper

Most pulp and paper mills include their own water and wastewater treatment plants where many of Sulzer's products are used. The HST turbocompressors are often installed for the mills' various aeration processes and have proven to be extremely reliable.

Wastewater treatment

Food and beverage

Wastewater streams from sugar, starch, brewing, dairy, slaughterhouse and beverage industries all contain high amounts of organic matter, which makes the HST turbocompressor an excellent choice.

Yeast fermentation
Wastewater treatment

Producing yeast requires high volumes of air with pressure depending on the liquid level in the fermentation tanks. In these applications, the HST turbocompressor delivers perfectly clean air and can operate smoothly with extensive (wide) flow/pressure variations and frequent starts and stops.

Chemicals and pharmaceuticals

Waste streams generated in chemical and pharmaceutical sectors can be complex, with high loads of contaminants, toxins and organic content. Membrane bioreactors (MBR) are becoming the preferred treatment method because of their high biodegradation efficiency and capacity to absorb shock loads. Being extremely flexible, the HST turbocompressors are the perfect complement to MBR systems, both for aeration and air scouring purposes.

Combustion
Wastewater treatment

Many chemical plants include some combustion processes where high volumes of air are compressed before being mixed with gas in burners. Safe and reliable equipment is a must to avoid any risk of explosion. The HST turbocompressor meets this request also providing 100% clean air to ensure optimal combustion in all conditions.



Mining and metals

Effluents from mines or metal processing plants are mostly treated with physical and chemical methods, but some biological treatment can also be needed. The HST turbocompressor is then at the heart of the aeration process. Especially in harsh conditions, its proven reliability becomes a major advantage.

Froth flotation process allows separation of valuable minerals from worthless components in cells fed by forced air. The pressure needs are well accommodated by the HST turbocompressors. Also, their minimal need for maintenance is highly appreciated in remote areas.

In the steel coils galvanizing process, an impinging air knife jet controls the Zn coating thickness by removing excess zinc from the moving substrate. For optimal quality coating, the HST turbocompressor delivers an oil-free, non-polluted air stream without pulsations.

Power generation

Circulating Fluidized Bed (CFB) boilers include a sand recovery system with loop seal from cyclone to furnace. The loop seal is a sand trap with injection of compressed air creating a pressure lock. The HST turbocompressors are well-referenced in this application since they are able to run safely even in harsh conditions.

Most coal-fired power generation plants worldwide are equipped with Flue Gas Desulphurization (FGD) systems. Using HST turbocompressors with integrated air flow meters can ensure the exact amount of oxidation air in the absorber.

Other manufacturing

The HST turbocompressors are the best choice for numerous other needs for low pressure. Whether a new installation or a replacement for an existing blower, they will always offer high efficiency and reliable operation with best overall lifecycle cost.



Flotation cells
Air knife stripping



Sand recovery (CFB)
Oxidation (FGD)



Air cooling and drying
Surface cleaning
Combustion
Process air

Features and benefits

Due to its innovative design, the compact HST turbocompressor has no wearing parts and uses no lubricants, thus requiring minimal maintenance. The unique technology enables optimal operating efficiency with minimized energy consumption and reduced environmental impact.

High efficiency guarantees optimal life cycle costs

- An excellent combination of superior, well-proven designs ensures energy savings and low lifecycle cost
- Single impeller design ensures maximum efficiency
- The high-speed motor is designed to match the required speed of the impeller
- Magnetic bearings provide more than enough force and with zero friction allow for speeds unachievable with traditional technology

Low-noise operation eliminates the need for additional soundproofing

- Silent operation is integrated into the design
- Integrated silencers remove the noise without adding to installation cost
- Quiet running means a better working environment for employees and less noise pollution in the plant vicinity

Simple, compact design that fits everywhere

- Low height and flexible connection options make the unit easy to install
- The air-cooling system, and in certain sizes even the outlet diffuser, silencers and other components are all incorporated into the cabinet, which eliminates the cost of installing separate accessories
- Numerous installation arrangements possible
- No need for any special foundation
- Can be transported on a pallet truck

- ① Compressor controls
- ② Motor outlet silencer
- ③ Magnetic bearing controller
- ④ Battery back up
- ⑤ Blow off valve with silencer
- ⑥ Variable speed drive



Magnetic bearings reduce operating and maintenance costs

- No physical contact between rotating and stationary components means no mechanical friction or wear
- Proven oil-free magnetic bearing technology eliminates the need for lubrication and makes the bearings maintenance free
- Real-time monitoring built in for maximum safety

Fully air-cooled design for optimized safety

- No liquid inside the machine eliminates the risk of leakage or any external contamination
- No pump, no heat exchanger, no fan
- Nothing that can freeze, boil or needs regular changes

State-of-the-art connectivity for maximum security and flexibility

- A full complement of field bus options is available for local connectivity
- Secure connectivity option for communication over IP networks is available for e.g. remote trouble-shooting

Off-the-shelf VFD

- Standard design VFD means full worldwide support and quick access to spare parts

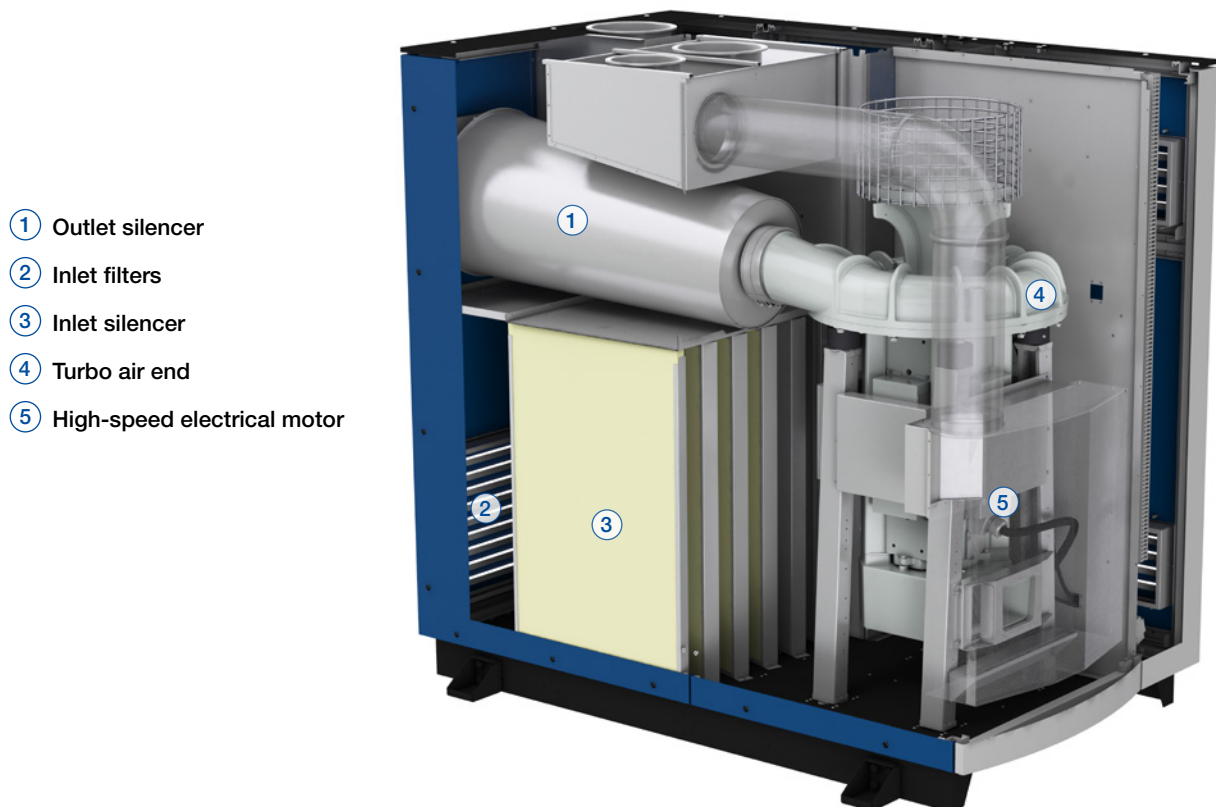

Sulzer's unique high-speed technology

Turbocompressors from Sulzer have a solid reputation for quality and reliability. Our unique high-speed technology has been tried and tested over two decades of operation.

Sulzer pioneered the use of magnetic bearings, which offer better stability and performance than any other type of bearings. Unique for the industry, our bearings are developed and produced inhouse for high-quality, efficient, problem-free operation.

Only one moving part

Conventional compressors may contain hundreds of moving parts. Turbocompressors built with our high-speed technology have just one: a single shaft that functions as the motor's rotor, upon which the impeller and cooling fan are mounted.

Flow is controlled by speed alone, which eliminates the need for inlet guide vanes or outlet diffuser vanes with complex mechanics that can wear or break down and need frequent maintenance.

Motor efficiency through design

The turbocompressor's motor is custom-designed and offers unmatched electrical efficiency. The motor is driven through a built-in frequency converter.

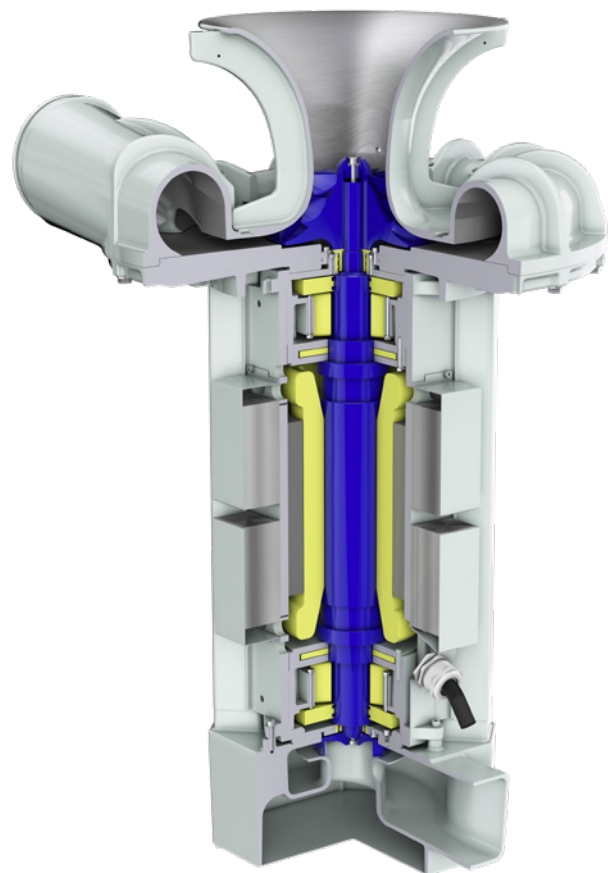

No contact, no wear

The magnetic bearings used in our technology permit motion without mechanical friction or wear. Even during starts and stops, there is never any contact between the rotating and static parts. The lack of contact also eliminates vibration, leading to reduced noise, higher reliability and longer component life.

Real-time monitoring built in

The magnetic bearings are continuously regulated by a monitoring system, which gives you access to full machine diagnostics without additional hardware. Non-contact position sensors check and adjust rotor position thousands of times per second to compensate for any undue movement. Should any problem occur, the system issues a warning or triggers a fault and if necessary stops the turbocompressor to protect the machine.

No liquids for added safety

Our high-speed technology is 100% air cooled and completely liquid-free. It means there is no risk for potentially dangerous leakage or contamination. There is nothing that can boil or freeze and nothing that needs to be exchanged, which in turn increases durability and reduces maintenance.

- ① Touch down bearing
- ② Position sensor
- ③ Radial actuator
- ④ Axial actuator
- ⑤ Magnetic bearing controller
- ⑥ Back up battery

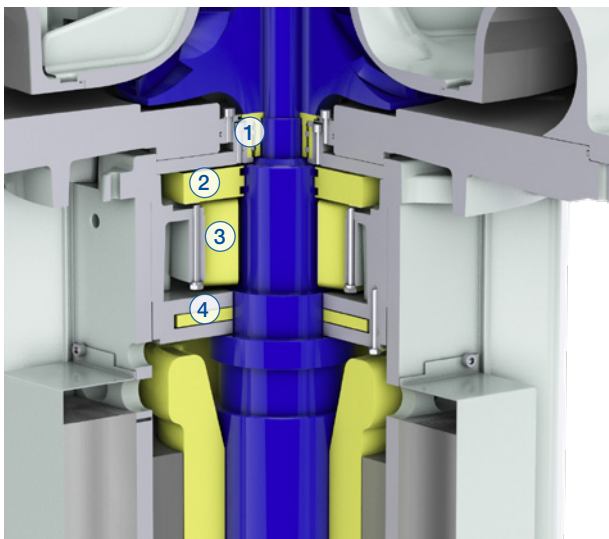

Optional features

Process inlet air from the compressor room

Especially for the smaller sizes of the HST turbocompressor range it makes sense to consider configuring the unit to take the process inlet air from the compressor room. Filtering and silencing are then built into the compressor package and no inlet piping is needed.

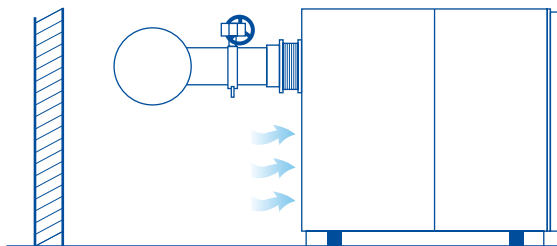

Inlet air piped from the outside

It is often not convenient to draw large amounts of air from the compressor room. If the surroundings are dusty it is better to put the air filters at a distance and elevated from the ground. This option means air for each compressor is piped from a filter unit positioned at a distance.

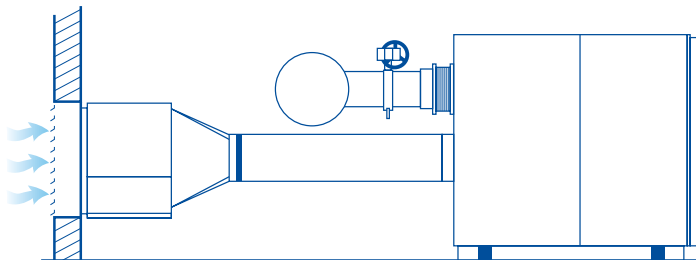

Cooling the compressor with forced air cooling

In dusty, humid or hot surroundings, forced air cooling can be a good way to get cooling air into and out of the compressor. The filtering or the cooling air is then done at the inlet of the pipe. Air is propelled into the compressor with a fan and the cooling air is discharged out from the room. This option minimizes the amount of heat discharged into the compressor room.

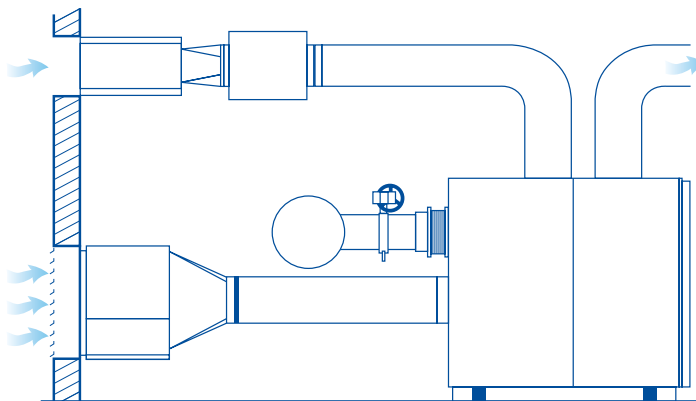

Locked stop button for added safety

The locked stop button is placed beside the other controls for easy access. After pressing the button, it will remain pressed down thus preventing any restart of the machine, e.g. by remote control.



Heaters

In humid climates, heaters for the control cabinet or motor compartment will keep the electrical parts in the corresponding areas dry.



Our HST turbocompressors are produced at the factory in Kotka, Finland. The factory has manufactured pumps, agitators, vacuum pumps and compressors for more than 150 years. We update the facility continuously in order to offer a modern, clean and efficient home for the products that we build here.

Sulzer always strives for the highest product quality, the best treatment of the environment and top-of-the-line health and safety. We embody this approach in our culture that encourages continuous improvement of processes, products and people.



Control alternatives

Connecting the HST turbocompressor directly to plant automation systems

The control system of the HST turbocompressor allows for a connection to a PC, either locally or via Internet. By connecting the turbocompressor to the plant automation system, its relevant functions can be accessed through these systems too.

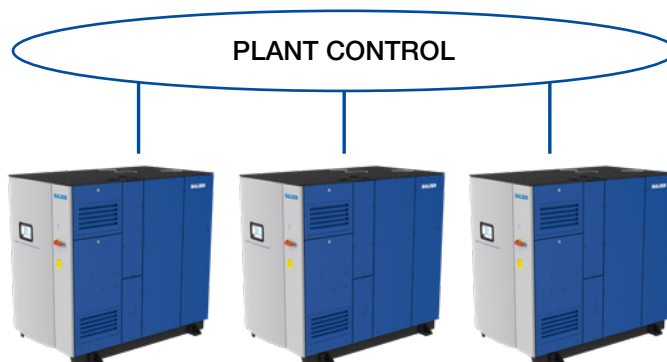

Master Control Unit MCU 300

The master control unit will operate an optimal number of HST turbocompressors at their respective optimal operational points in order to maximize the energy savings. To the plant level automation, a group of up to 8 compressors will appear as one large unit for production of compressed air.

The MCU 300 is available in models supporting common field buses. Furthermore, it can be adapted to special requirements from the process or upper level automation. If required, Sulzer can deliver an MCU for controlling both HST turbocompressors and legacy blowers, allowing them to work side-by-side and optimizing energy use.

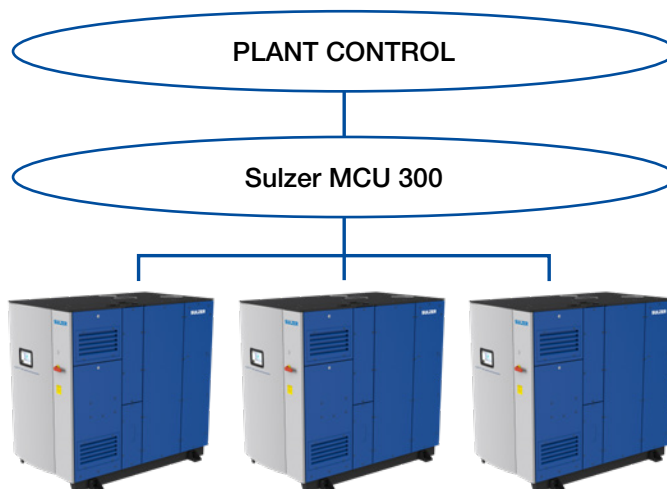

Fieldbus connection

All models in the HST range are ready for connection to modern field-bus networks. A full range of control commands is implemented. For monitoring purposes, a wide selection of registers is visible to the upper level automation.

Remote connection

The HST Secure Remote Connection for Service Personnel creates a secure link between an authorized service technician and a group of installed HSTs. As part of e.g. a maintenance agreement, this link can be used on a regular basis for monitoring availability and for determining maintenance needs. Furthermore, many types of preventive check-ups as a multitude of operating parameters are stored in the HST machine for future reference. In case a warning or a fault is indicated on the local display, trouble-shooting can be done remotely thus cutting unnecessary site visits to a minimum. If manual intervention is necessary, the remote connection will help in preparing for the visit.

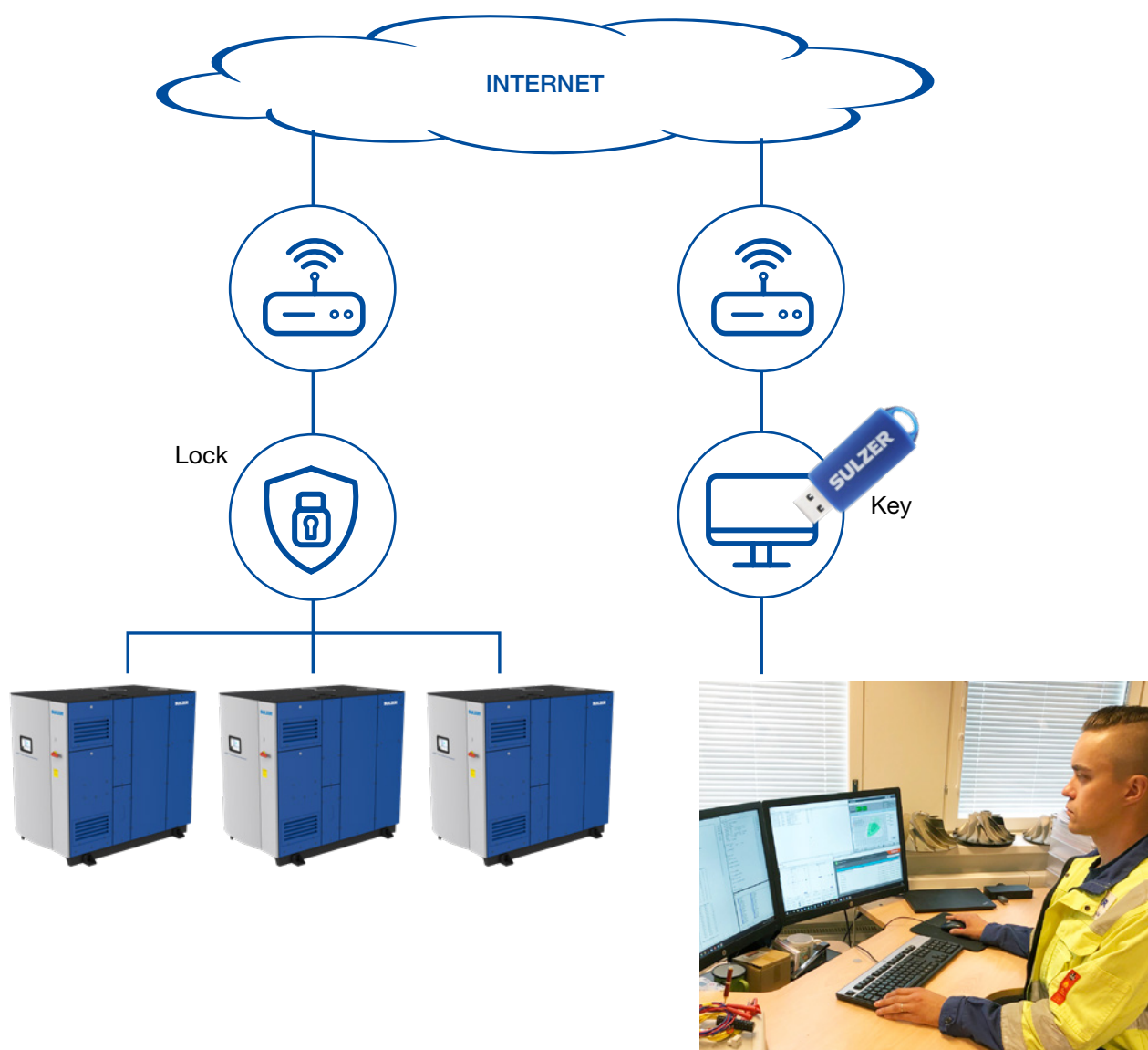

Common accessories

Inlet silencer

Properly sized and fabricated inlet silencers will minimize the noise travelling from the turbocompressor through the pipework to the air inlet. Depending on the type of pipe, the silencers can either be configured for connection to ventilation piping or equipped with flanges in both ends. On some HST models, the inlet silencer is built into the package.

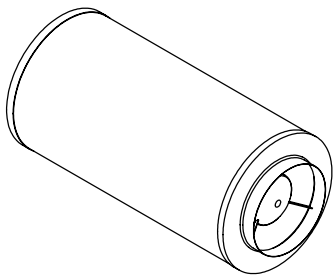

Outlet cone silencer

The length of piping extending from the compressor discharge can be extensive. Applying preselected outlet silencers directly downstream from the compressor will minimize noise radiated from this pipe as well as noise from the end of the pipe. The Outlet cone silencer is a combination of an outlet silencer and a diffuser saving space and installation cost. On some HST models, it is built into the package.

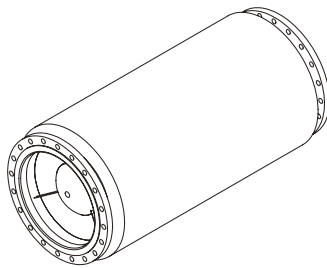

Outlet diffuser

The outlet diffuser gently adapts the high-speed flow in the turbocompressor to the pipework downstream with a minimum of pressure loss. Part or all of the outlet diffuser may be built into the compressor package.

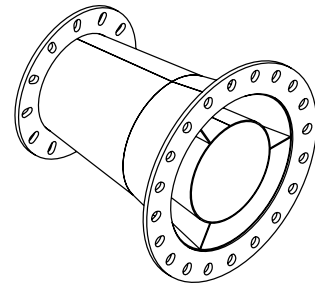

Motor cooling air silencer

For best noise performance, you also need to address cooling air noise. It is recommended to use a pipe to exhaust the motor cooling air from the compressor room. The motor cooling air silencer can be applied right at the compressor package. On some models, this function is built in.

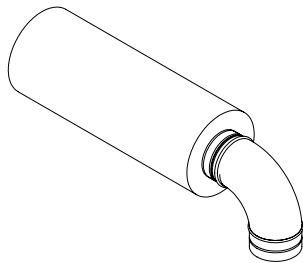

Blow-off air silencer

During start-up, the compressor will blow off air through the integrated blow-off valve. This can cause some noise. To minimize this noise, one or several blow-off air silencers can be mounted after the blow-off discharge. On some HST models, this is a standard built-in feature.

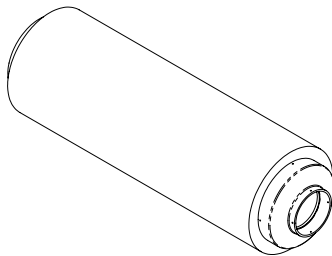

Inlet box silencer

This accessory can be installed with a horizontal inlet directly in front of the inlet to the machine to provide a simple and compact installation.

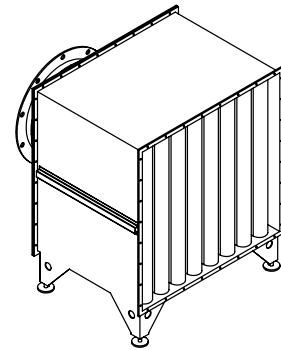

Inlet filter

The compressor requires good filtering of the inlet air. Unfortunately, inlet air filtering can cause extra pressure loss. A properly configured inlet filtering solution will provide low losses and easy exchange of filter material.

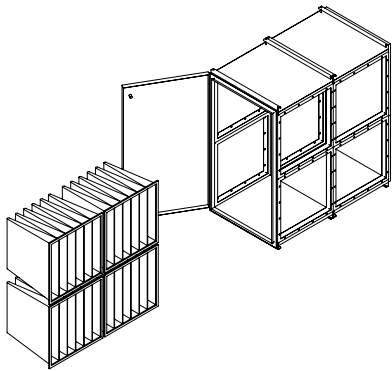

Flexible joint

In order to prevent any strain coming from the pipework from negatively affecting the compressor, the machine and piping need to be joined in a flexible way. We provide flexible joints in relevant sizes for the inlet (needed if heavy pipes are used) and outlet connection.

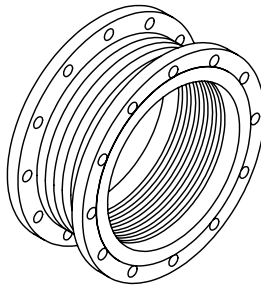

Back-flow barrier

To prevent pressure from leaking out from the compressor, a back-flow barrier (often called a check valve) is necessary. Properly specified low-loss double-flap valves are available for all models.

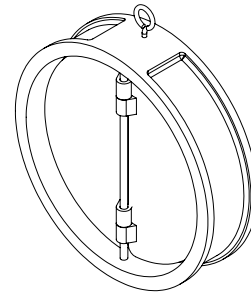

Manual outlet valve

We recommend installing a manual outlet valve as the final component of the discharge in order to be able to isolate the turbocompressor from the pipework when maintaining it.

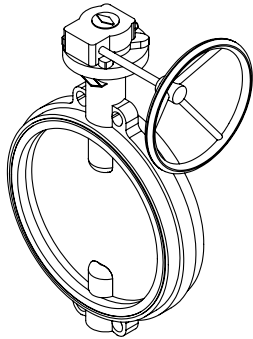

Radial inlet

For models with a horizontal inlet, this component combines two functions. It works as a silencer and creates a 90-degree bend, which means the inlet can come from any radial direction.

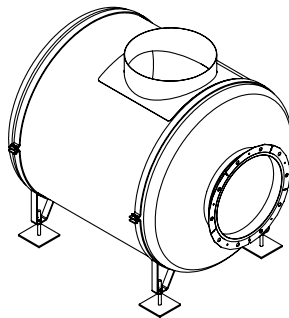

Outlet flange elbow

This component with carefully designed vanes can be installed to provide a quick turn directly after the outlet and minimize the pressure loss typically associated with sharp bends.

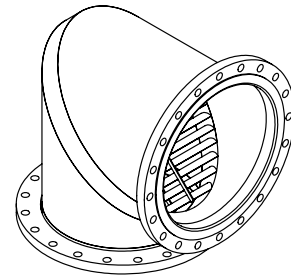

Service when and where you need it

Since water and wastewater plants rely on continuously operating equipment, Sulzer offers all the services and technical support you need to maintain your performance.

We have an extensive network of workshops that places us close to you for rapid response. Staffed by highly trained engineers and closely partnered with our manufacturing centers, our workshops are ready to help you whenever and wherever you need it.

On-site services

- Supervision of HST turbocompressor installation
- Start-up and commissioning
- Site service and periodical maintenance
- On-site testing and commissioning of master control unit (MCU)

Specialist solutions for asset management

- Optimization of aeration systems
- Flexible maintenance packages providing optimal lifecycle cost
- Control, automation and monitoring

Upgrades of existing equipment

We are committed to keeping your products in the best possible working condition. As most key components are designed and manufactured by us, we provide excellent parts and support availability. For externally sourced parts that are no longer obtainable we try to offer a suitable replacement.

Quick replacement and rental compressors

Downtime puts your operation at risk. Should any problem occur, we offer rental machines ready to go to service immediately or quick shipment of replacement machines. For more information, contact your local Sulzer office.



Materials

| Part | Material |
|----------------------|---|
| Impeller | High-strength aluminum alloy |
| Volute and backplate | Aluminum alloy |
| Motor frame | Aluminum alloy |
| Enclosure | Plated steel with structural steel base |

Operating data

| | HST 2500-1 | HST 2500-2 | HST 20-4500 | HST 20-6000 | HST 6000-2 |
|-----------------------------------|---------------|----------------|----------------|----------------|----------------|
| Airflow range, Nm ³ /h | 900 - 4'000 | 600 - 2'200 | 1'800 - 5'800 | 2'300 - 7'000 | 1'800 - 6'800 |
| Pressure rise range, kPa | 30 - 85 | 30 - 125 | 30 - 100 | 30 - 90 | 80 - 125 |
| Maximum input power, kW | 69 - 90 | 69 - 100 | 100 - 150 | 125 - 190 | 240 |
| Maximum noise level, dB | 69 | 74 | 62 | 62 | 92 |
| | HST 30-36-1 | HST 30-46-1 | HST 30-58-8 | HST 30-38-2 | HST 40 |
| Airflow range, Nm ³ /h | 2'500 - 9'800 | 3'000 - 12'400 | 3'800 - 15'000 | 3'000 - 10'000 | 4'400 - 16'100 |
| Pressure rise range, kPa | 30 - 90 | 30 - 90 | 30 - 75 | 60 - 130 | 30 - 85 |
| Maximum input power, kW | 190 - 300 | 190 - 350 | 190 - 350 | 250 - 350 | 300 - 400 |
| Maximum noise level, dB | 73 | 75 | 75 | 75 | 70 |

| | All HST models |
|---------------------------|-------------------------|
| Power supply | 380 - 690 V |
| Input frequency | 50 - 60 Hz |
| Protection class | IP33D |
| Thermal motor protection | PT100 |
| Permitted chemical vapors | IEC 60721-3-3 class 3C3 |

Making water go around. Water and wastewater solutions by Sulzer.

Sulzer offers a broad range of pumps and related equipment for water production and transportation as well as wastewater collection and treatment for municipalities and industries. Our expertise also includes separation technologies, and services on rotating equipment.

E10600 en 3.2024, Copyright © Sulzer Ltd 2024

This brochure is a general presentation. It does not provide any warranty or guarantee of any kind. Please, contact us for a description of the warranties and guarantees offered with our products. Directions for use and safety will be given separately. All information herein is subject to change without notice.

